

FINGERPRINT DOOR LOCK

M501

Installation

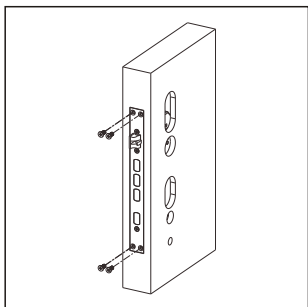

- a** Drill the holes on the door and then install the mortise into the door;

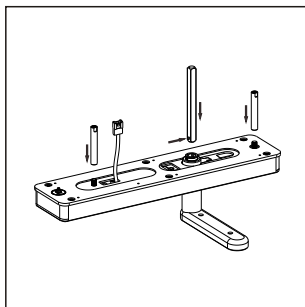

- b** Install the spindle into the handle hole in the front panel, and then insert the rod and fasten it;

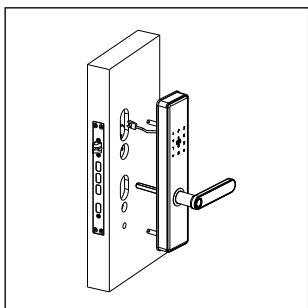

- c** Install the front panel on the door

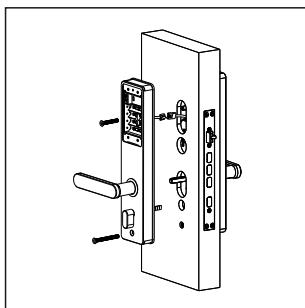

- d** Connect the cable between the front and back panels

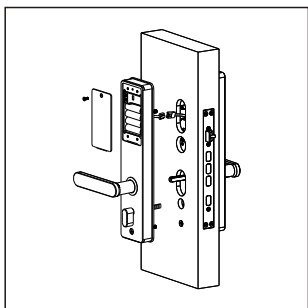

- e** Install the back panel on the other side of door, and then fasten both panels

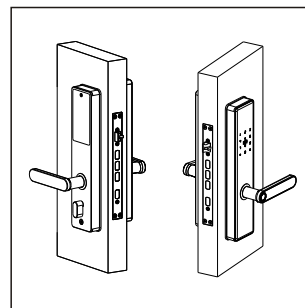

- f** Install the batteries and test the installation to confirm the installation is successful.

Product Guide

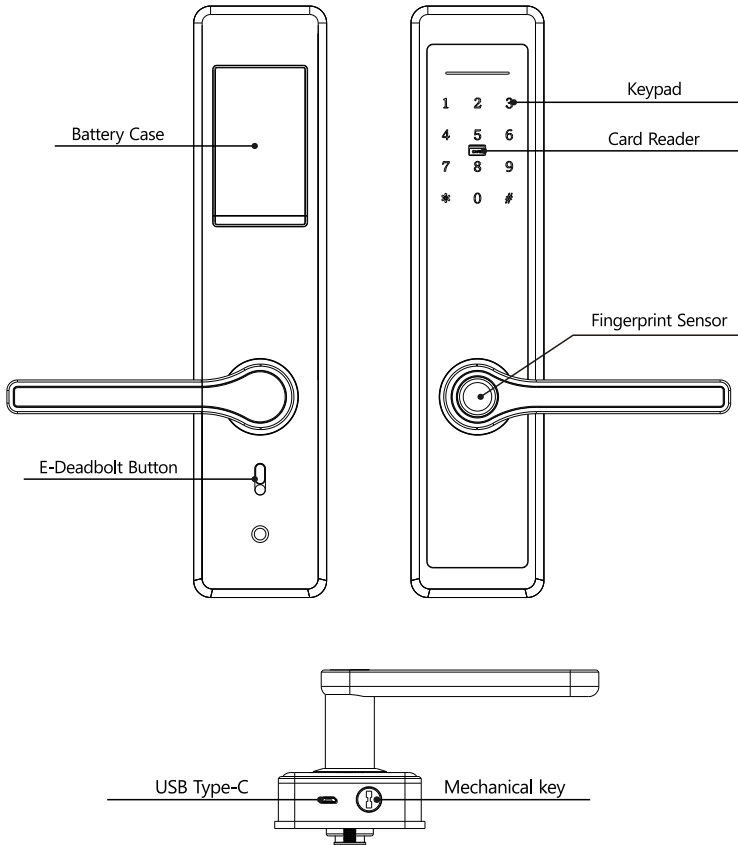

Brief Introduction

1. The default unlocking password is "123-456" when the lock is under factory state;
2. There are total 300 users available. The ID numbers for the users are as following:
001~009: Master User;
010~300: Normal User;
3. The password can be 6 to 10 digits;
4. The USB Type-C port is at the bottom of front panel, which is the port for emergency power supply;
5. The lock has 2 unlocking modes: Single Unlocking Mode and Double Unlocking Mode.
6. If the lock has Wi-Fi module, you can download the Tuya App to connect the lock with the Wi-Fi.

Operation

1 Register Master User

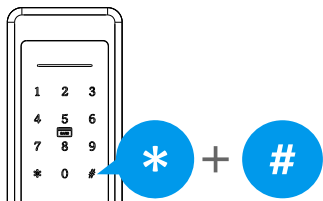

a Input * + # to log in the system

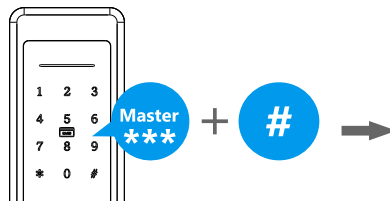

b Input the master user for authorization

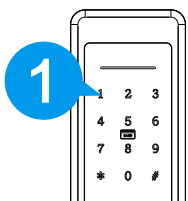

c Input 1 for master user

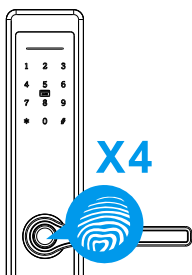



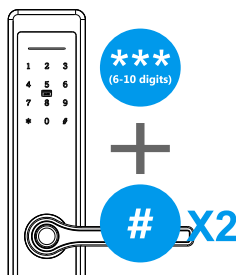

d Fingerprint: place the fingerprint on the sensor for 4 times to register

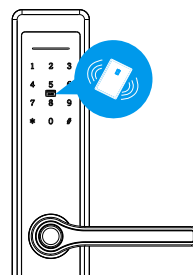

e Password: input the password, and press # to confirm in 2 times



f Card: place the card close to the card reader to register

-  **The master password can be 6 to 10 digits;**
-  **For new lock, there is no master user authorization needed. You can register the master user directly. The first user registered in the lock has to be the master user.**
-  **There are up to 9 master users available in the lock. The first registered user comes with ID "001", the second registered user comes with ID "002", until the 9th registered user comes with ID "009".**
-  **It is suggested to make a list to record the users' ID numbers for a better management.**
-  **Once finishing the operations, please try to unlock the lock to confirm the operation is successful.**

2 Add Normal User

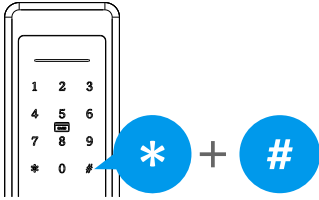

a Input * + # to log in the system

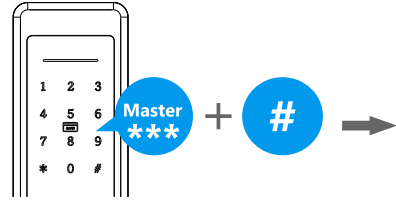

b Input the master user for authorization

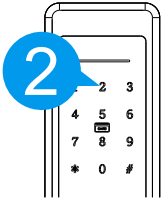

c Input 2 to register normal user

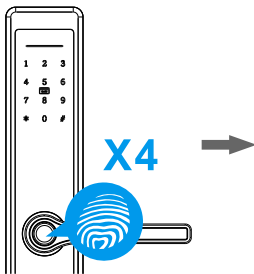

d Fingerprint: place the fingerprint on the sensor for 4 times to register

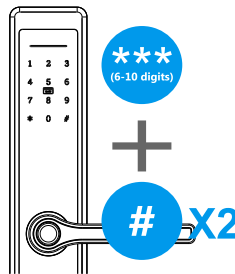

e Password: input the password, and press # to confirm in 2 times

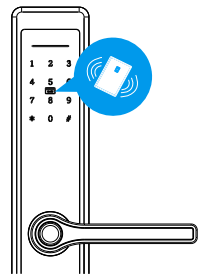

f Card: place the card close to the card reader to register.



The password can be 6 to 10 digits;



There are up to 291 normal users available in the lock. The first registered user comes with ID "010"and the 300th registered user comes with ID "300"



It is suggested to make a list to record the users' ID numbers for a better management.



Once finishing the operations, please try to unlock the lock to confirm the operation is successful.

3 Delete User (Single Master or Normal User)

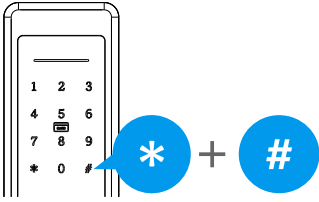

a Input * + # to log in the system

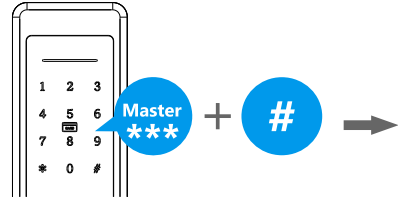

b Input the master user for authorization

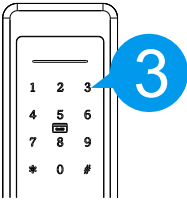

c Input 3 to delete user

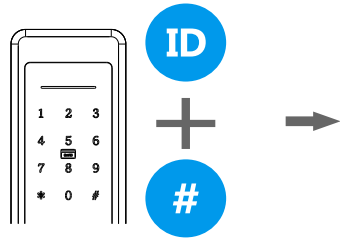

d Input the ID number you want to delete, press # to confirm, or you can input the user information directly to delete.

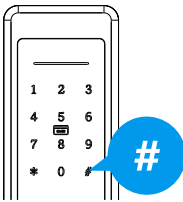

e Press # to confirm to delete



If you want to delete the master user, the master user used to log in the system cannot be deleted.



Once finishing the operations, please try to unlock the lock to confirm the operation is successful.

4 Unlocking Mode

Sometime if you need a higher security level, you can set up the lock in double unlocking mode, which the unlock needs 2 registered users for unlocking each time.

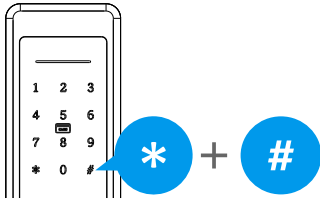

(a) Input * + # to log in the system

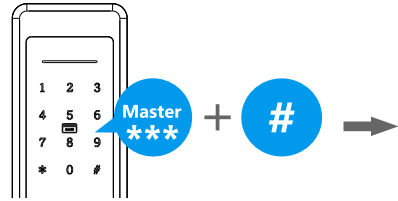

(b) Input the master user for authorization

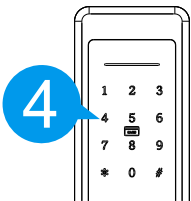

(c) Input 4 for system setting

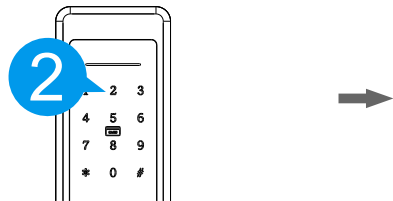

(d) Input 2 for unlocking mode setting

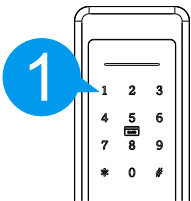

(e) Input 1 for single unlocking mode

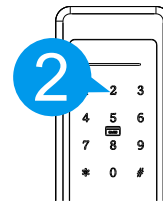

(f) Input 2 for double unlocking mode

 **Once finishing the operations, please try to unlock the lock to confirm the operation is successful.**

 **When the lock is under double unlocking mode, you have to input 2 registered normal users to unlock every time.**

 **The master user can unlock directly even the lock is under double unlocking mode.**

5 Passage Mode

When the lock is required to unlock frequently, set the lock to passage mode can let the people unlock the lock without any identification.

Enable:

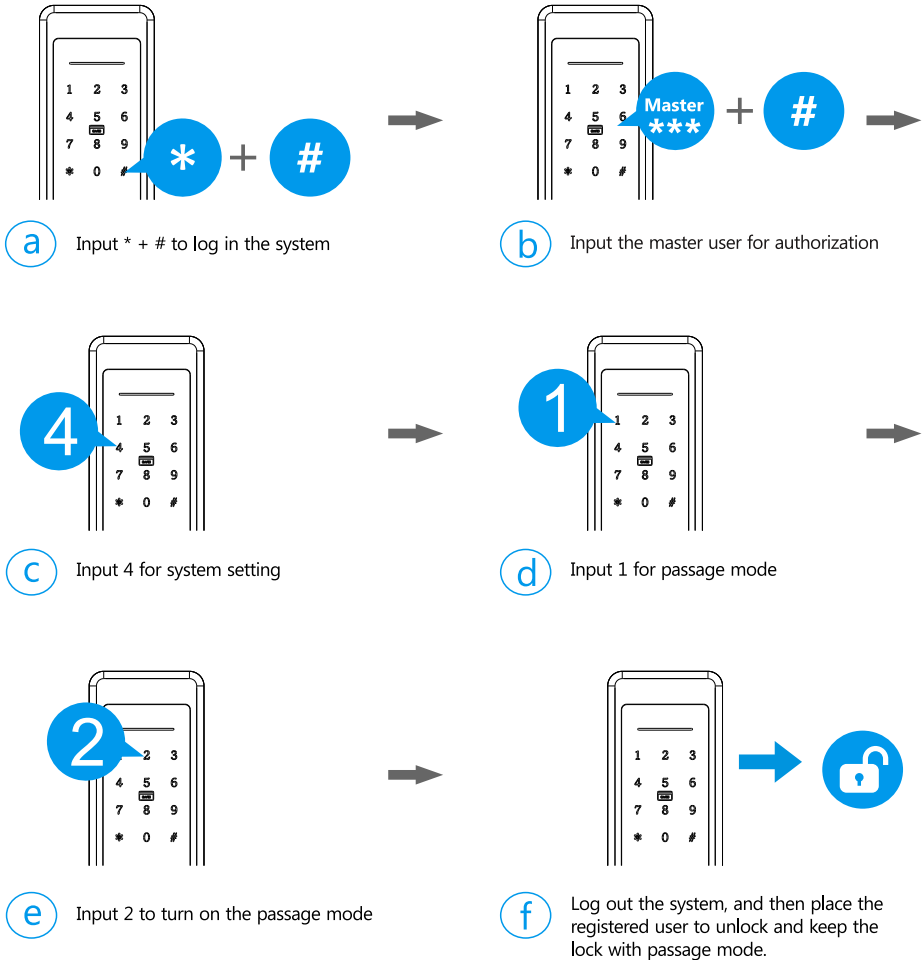

Disable:

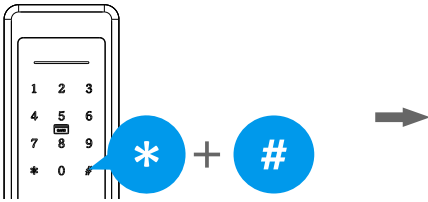

a Press * + # to cancel the passage mode temporarily.

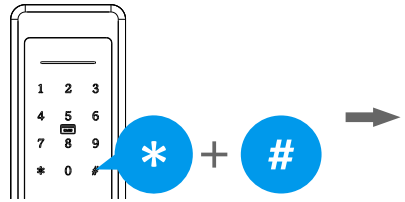

b Input * + # to log in the system

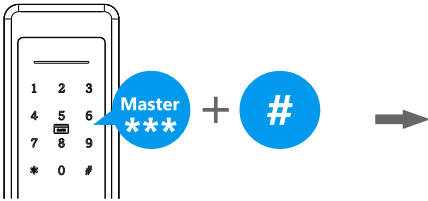

c Input the master user for authorization

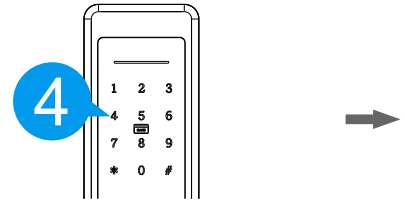

d Input 4 for system setting

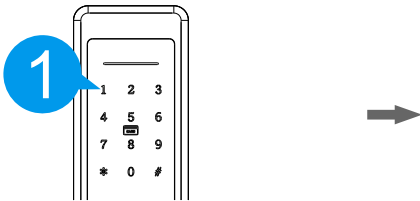

e Input 1 for passage mode

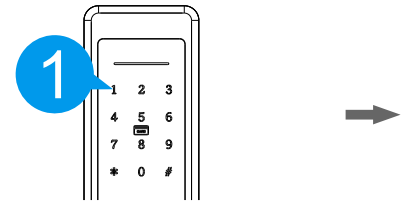

f Input 1 to turn off the passage mode

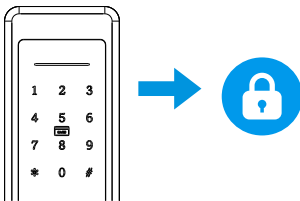

g Log out the system, and then place the registered user to unlock and make the lock return to normal state.

7 Restore The Lock

When the lock has problems and you can try to restore the lock to solve the problems

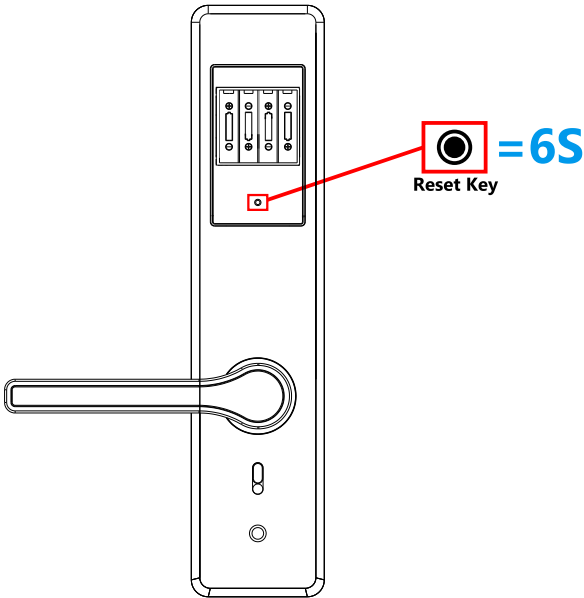

Press the reset key in the battery case for 6 seconds, and then the lock will be restored to the factory default.

8 Tuya Wi-Fi Setting

This function is only available with the lock installed Tuya Chipset (model: M501 Wi-Fi)

1. Download and install the APP on the mobile phone.
2. Register a master user in the lock, then move to the Tuya APP.
3. Select the "Security & Sensors" – "Lock (Wi-Fi)"

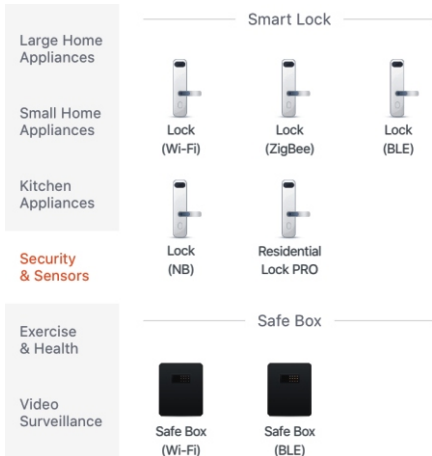

4. Select the Wi-Fi, and input the password for the Wi-Fi;

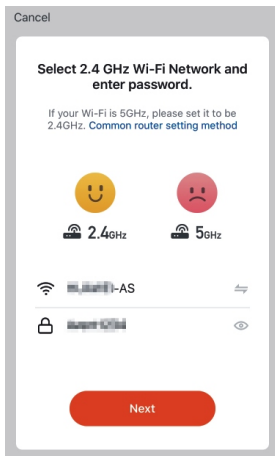

5. Make the connection is "EZ Mode", and click next

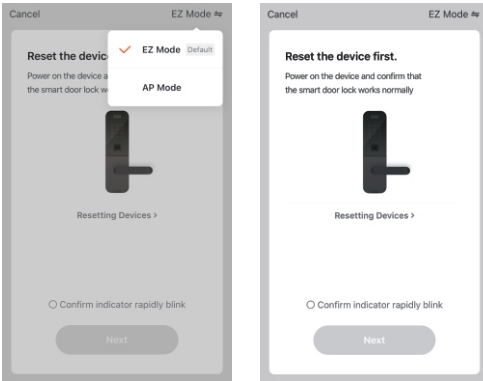

6. Press the reset key in the battery case, and let the APP search the lock

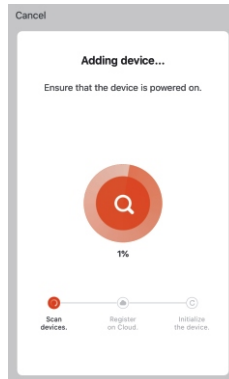
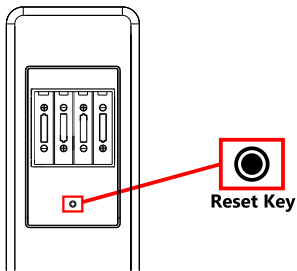

7. Wait some time and the APP will finish the connection with the lock automatically. You can give a name for the lock to manage it easily.

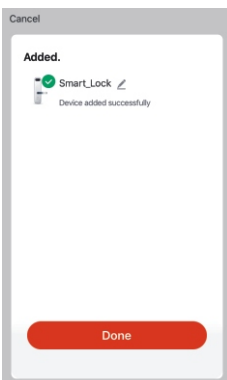

9 Remote Unlock

1. Activate the lock, and input 9# to send the unlock request to the APP;
2. The APP will receive a message with unlock request

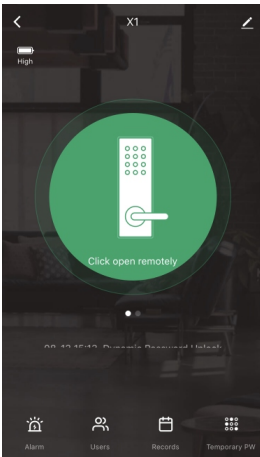

3. Confirm the request to unlock

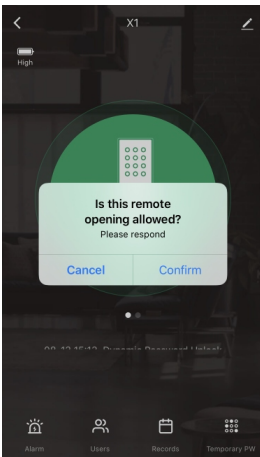

10 Temporary Password Unlock

1. Select the "Temporary PW" option;

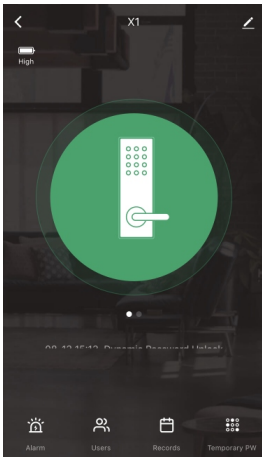

2. Select "Add" to generate the password;

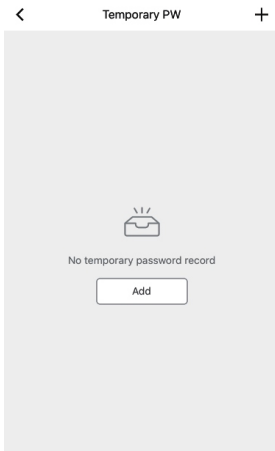

3. Input the password you want, or just click "Get Randomly" to generate the password;

< Temporary Code Setting Done

Please enter temporary password

Get Randomly

Name

Please set the password name

Effect of time

Please set the effective time

The failure time

Please set the expiration time

4. Input the Name, Effect of time, Expire of time, and then click done to save the setting;

< Temporary Code Setting Done

Please enter temporary password

Get Randomly

Name

Please set the password name

Effect of time

Please set the effective time

The failure time

Please set the expiration time

5. Activate the lock and synchronize the temporary the password to the lock

6. Use the password to unlock as daily.



After generate the password, input 9# to send a request to the App, and then synchronize the password to the lock

11 Remote Dynamic Password Unlock

1. Move to the interface of dynamic password;

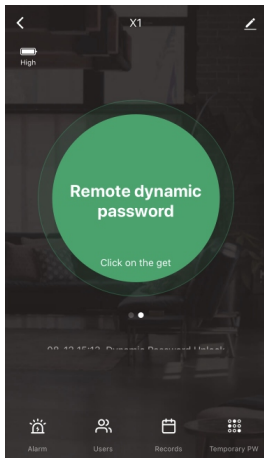

2. Click the icon and generate the password

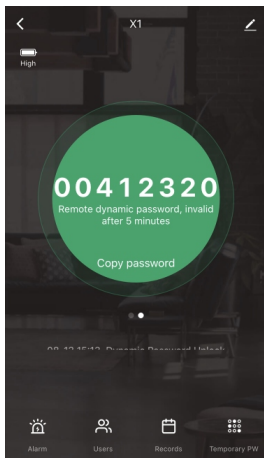

3. Use the password to unlock

 ***After generate the password, input 9# and the password to unlock***

 ***The password is only available in 5 minutes.***